

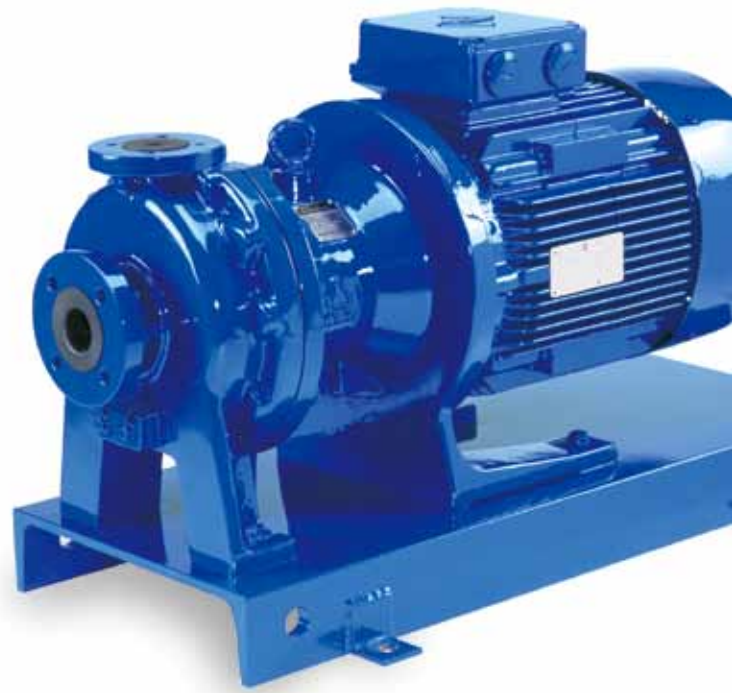

IWAKI
MAGNETIC
DRIVE
PUMPS

MDM



Patent

JAPAN / U.S.A. / TAIWAN / EU / CHINA

Solutions for chemical handling applications

Magnetic drive process pump resistant to dry run damage

The MDM Series of Magnetic drive process pumps have wetted parts made of fluororesin. Natural PFA and CFRETFE being standard materials of construction. The MDM features a unique mechanism which gives a greatly improved performance against dry running (Non contact system). Applications cover a wide range of chemical process duties from acid to alkali together with high purity chemicals for the semiconductor industry.

Unique design prevents dry running

(Non contact system) (PAT.)

The pump design features a mechanism to withstand dry running. High magnet power of the rare earth magnets prevents the magnet capsule coming into contact with the thrust ring of the rear casing, thus preventing melting of fluororesin components due to heat generation. This greatly improves resistance against dry running in comparison with conventional magnetic drive pumps made of fluororesin.

Note: Only CF type (fitted with high density carbon bearing) can cope with dry running. Dry running is not permitted in the case of KK type.

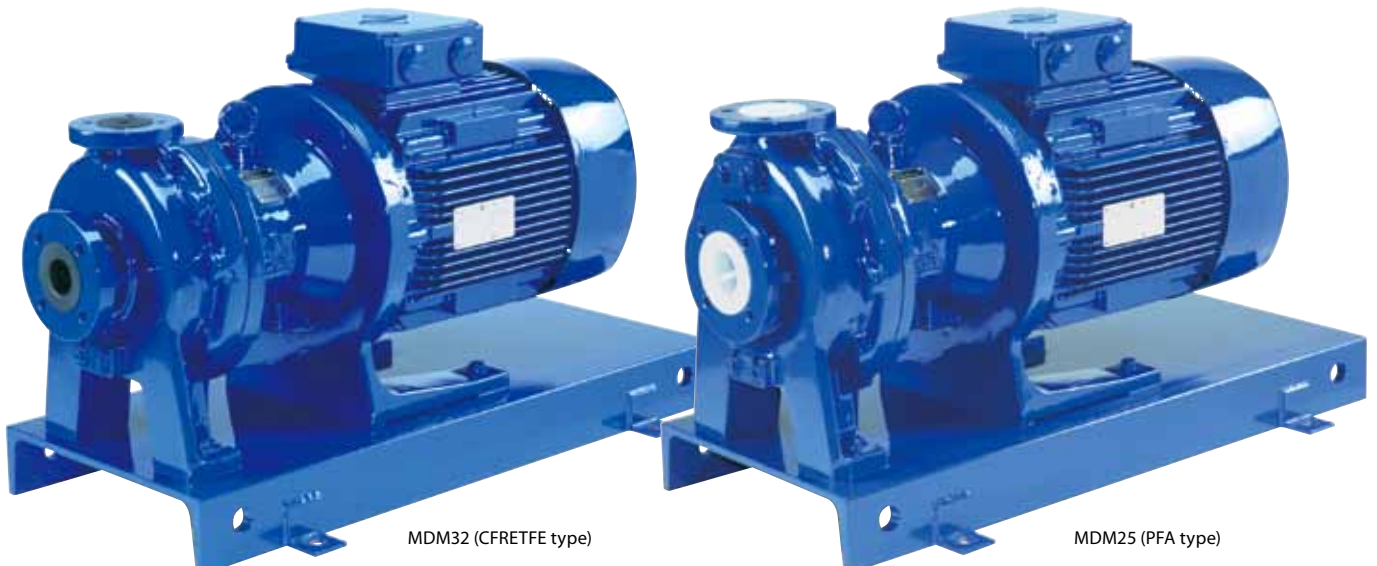
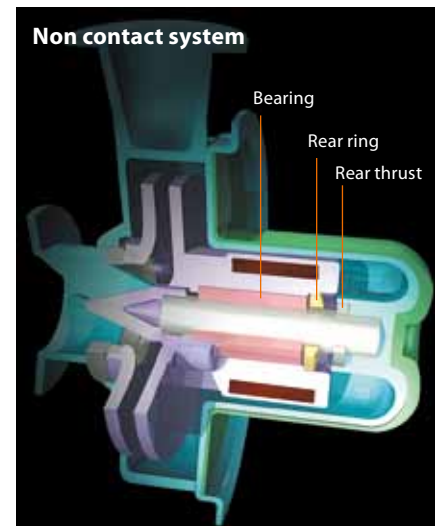

ETFE and PFA available in standard models

Carbon fibre reinforced CFRETFE and PFA linings can be supplied to meet many varying duties. PFA being a natural unfilled material generates fewer contaminants and makes it ideally suited for transfer of high purity chemicals.

Note: Long coupling type is only PFA version.

Highly durable structure

A ductile cast iron shell adds strength and durability to the outer peripheral surfaces of the fluoro-resin pump module. The rear casing which is placed under the highest stress is protected by a rear casing cover made from fibre reinforced plastic. This gives sufficient strength and eliminates the eddy current loss caused by the rotating magnetic field. Should it come into contact with the drive magnet unit, no spark would be generated and a high level of safety would be maintained.

Back pullout system

In order to facilitate inspection and maintenance, this series employs the back pullout system. This enables one to conduct inspections internally and replace parts without removing piping. The pump is designed to include safety measures that can prevent the liquid from leaking when the foot support (bracket) is pulled back.

Compliance with ISO standards (ISO2858/DIN EN22858)

The pump with a common base comply with ISO Standards in regard to piping connection.

Note 1: For compatibility in size with other series of our magnet pumps, please call us.

Note 2: ANSI and JIS standards are also available.

For details, please call us.

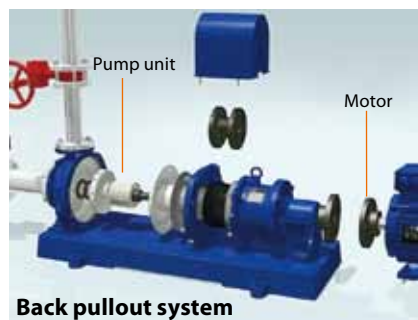

Back pullout system

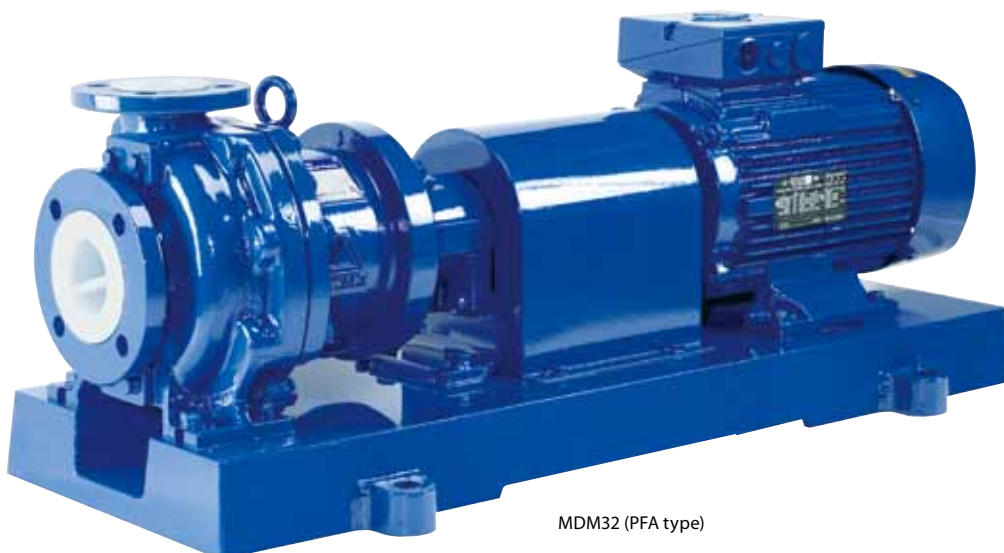

MDM32 (PFA type)

Construction

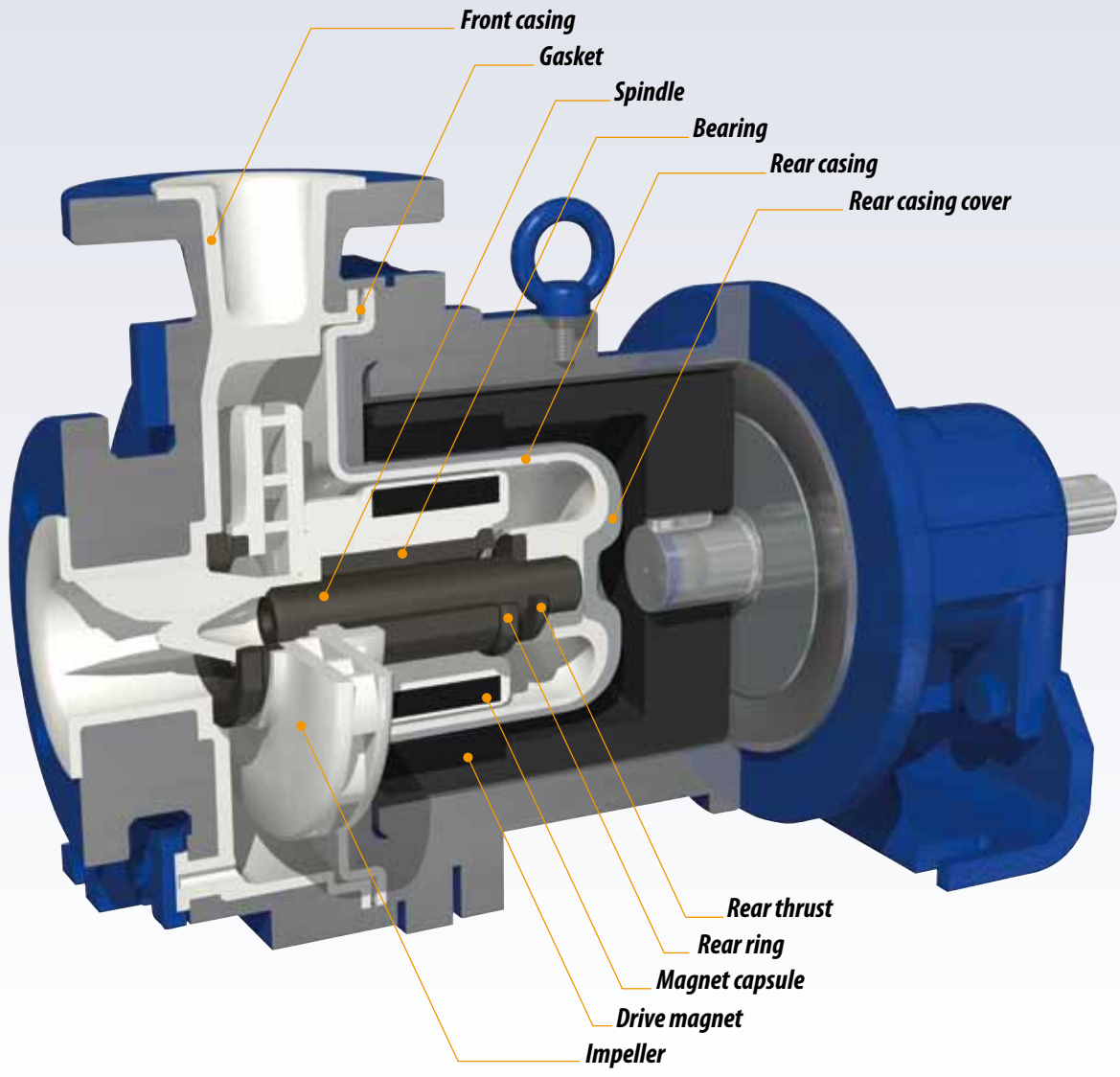

Wet-end materials

	Materials	ECF	EKK	PKK/NKK
1	Front casing	CFRETFE	SIC	PFA
2	Rear casing (Note 1)			
3	Impeller			
4	Magnet capsule			
5	Bearing	High density carbon	SIC	SIC
6	Spindle	High purity alumina ceramic		
7	Liner ring	PTFE (with Filler)		
8	Mouth ring	High purity alumina ceramic		
9	Rear ring	PTFE (with filler)	PTFE	
10	Rear thrust	PTFE		
11	Gasket	PTFE		

Note 1: Rear casing of MDM25-3 and MDM32-2 for over 80°C application is special construction (PAT.).

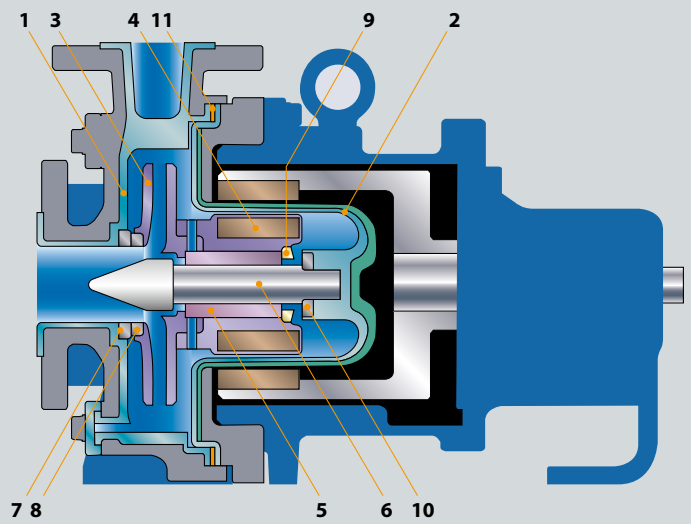

Front casing ETFE type

A moulding made of carbon fibre reinforced CFRETFE. It has both a high mechanical strength and excellent corrosion resistance. The outer peripheral surfaces are reinforced by a ductile cast iron outer casing in order to achieve excellent strength and durability.



CFRETFE type

Front casing PFA type

The ductile cast iron casing is a one-piece moulding with natural PFA fluoro-resin lining integrally moulded. This construction is free from contamination and ideal for transfer of clean liquids or with less particle generation.



PFA type

Note: For MDM25-1 PKK/32-1 NKK type a different moulding method is used.

Impeller

Closed type impellers are designed to give high efficiency. To ensure positive fixing of impeller to magnet capsule a spline system together with a pin fixing is employed. This prevents the impeller from moving axially off the magnet capsule (PAT.). MDM25 and 32 models now have impellers capable of reaching max. heads of 74 meters (50Hz) to widen the range of application.



CFRETFE type



PFA type

**Rear casing
Rear casing cover**

The fluoro-resin rear casing is strengthened by the outer rear casing cover which is manufactured in fibre reinforced plastic capable of withstanding a pressure of 1 MPa. (Note: For long coupling type, maximum pressure is 1.6MPa.)

This structure also eliminates any eddy current losses due to a rotating magnetic field. It also prevents sparks from being produced should the rear casing come into contact with the drive magnet unit.

A newly developed triple-layer casing (PAT.) is used for the high head models MDM25-3 and 32-2 when liquid temperature exceeds 80°C. This new design allows a rated 1.6MPa casing pressure overall temperature range. Since the front and rear casing are bolted together from the front casing side liquid does not leak out when the foot support (bracket) is pulled back.



PFA type with rear casing cover

Rear ring

As a precaution against abnormal running, for example cavitation or air entering the pump where the magnet capsule could move axially backwards a rear ring and thrust ring have been incorporated. The rear ring is designed to give minimal heat generation from contact and therefore heat generation is greatly reduced compared to conventional designs. This prevents surrounding fluoro-resin from melting. (PAT.)

Rear Thrust

The rear thrust withstands axial loads encountered from abnormal operation, it also minimizes heat generation.

Magnet capsule

High magnet strength rare earth magnets are totally encapsulated with fluoro-resin mouldings. Magnets are small and lightweight which increases the efficiency of the pump. Taking advantage of the high magnetic strength its new design of "Non contact system"(PAT.) was developed to protect pump from dry running. This enables us to offer pumps that will withstand dry running operation. (CF type only)



CFRETFE type

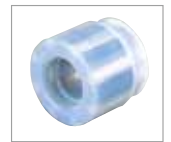

PFA type

Spindle

Both ends of the spindle are supported by the front casing and the rear casing (the fixed spindle type). There are two types of spindle; one is made of high purity alumina ceramic and the other made of SiC.



SiC type High purity alumina ceramic type

Bearing

Two standard bearing materials are available. SiC gives high resistance to abrasion. High density carbon withstands dry running operation. Bearings can be individually replaced.



SiC type High density carbon type

Gasket

A PTFE shrouded gasket is used to enhance sealing performance and corrosion resistance.

Specifications

2 pole motor type

50Hz

Model	Pump size Suction X Discharge	Impeller size	Capacity L/min	Head m	Motor kW
MDM25-1 (Impeller range 1)	40mm X 25mm	165	100	35.5	1.5 or 2.2
		160		33.5	
		150		29.0	
		140		25.0	
		130		20.5	
MDM25-2 (Impeller range 2)	40mm X 25mm	195	100	50.5	4.0, 5.5 or 7.5
		190		49.0	
		180		44.5	
		170		38.0	
		160		34.5	
MDM25-3 (Impeller range 3)	40mm X 25mm	225	100	74.0	5.5, 7.5, 11 or 15
		220		69.0	
		210		61.0	
		200		55.0	
		190		48.5	
MDM32-1 (Impeller range 1)	50mm X 32mm	165	208	35.0	4.0, 5.5 or 7.5
		160		32.5 <small>Note1</small>	
		150		28.5	
		140		25.0	
		130		20.5	
MDM32-2 (Impeller range 2)	50mm X 32mm	120	208	17.0	5.5, 7.5, 11 or 15
		225		70.0	
		220		67.5	
		210		60.0	
		200		54.0	
MDM40-1	65mm X 40mm	190	417	47.0	4.0, 5.5 or 7.5
		180		41.5	
		170		38.0	
		160		32.0	
		165		33.0	
MDM50-1	80mm X 50mm	165	833	38.5	5.5, 7.5, 11, 15
		160		35.5	
		150		31.0	
		140		26.5	
		130		22.0	
		120		17.5	
		110		13.5	

Note1: For long coupling type, head is 34.5m.

Note2: For long coupling type, head is 32.5m.

4 pole motor type

50Hz

Model	Pump size Suction X Discharge	Impeller size	Capacity L/min	Head m	Motor kW
MDM25-2 (Impeller range 2)	40 mm X 25 mm	200	50	12.0	1.5, 2.2, 4.0
MDM25-3 (Impeller range 3)	40 mm X 25 mm	225	50	15.0	1.5, 2.2, 4.0, 5.5
MDM32-1 (Impeller range 1)	50 mm X 32 mm	170	200	7.5	1.5, 2.2, 4.0
MDM32-2 (Impeller range 2)	50 mm X 32 mm	225	200	15.0	1.5, 2.2, 4.0, 5.5
MDM40-1	65 mm X 40 mm	170	300	7.0	1.5, 2.2, 4.0
MDM50-1	80 mm X 50 mm	170	500	8.0	1.5, 2.2, 4.0, 5.5

Common Specifications

• Temperature range of liquid handled	EKK/ECF: -20 to 105°C, PKK: -20 to 150°C, NKK: -20 to 120°C Note1	• Allowable maximum pressure	1.0 MPa (All long coupling type, MDM25-3 and MDM32-2 are 1.6MPa.)
• Allowable slurry (KK type only)	Please contact us.	• Standard color of paint	Ultra marine blue RAL5002

Note1: Please contact us when handling liquid temperature is outside range of 0°C to 120°C.
Should your requirement be beyond the specs. shown in this catalog, please contact your nearest Iwaki distributor.

Pump identification

MDM 40 - 150 1 E KK F 075 I - D 2 H

- Pump size (Suction X Discharge)**
 25: 40mm X 25mm
 32: 50mm X 32mm
 40: 65mm X 40mm
 50: 80mm X 50mm
- Wet-end main material**
 E: CFRETFE
 P: PFA
 N: PFA(MDM32-1 only)
- Type of motor**
 C: Long coupling type
 F: Flange motor
- Impeller size**
 100mm to 225mm
- Impeller range**
 1, 2, 3
- Material of Bearing / Spindle**
 KK: SiC/SiC
 CF: High density carbon/
 High purity alumina ceramic
- Motor output**
 015: 1.5kW 022: 2.2kW 040: 4.0kW 055: 5.5kW
 075: 7.5kW(2P) 110: 11kW(2P) 150: 15kW(2P)
- Special code**
 H: 80 to 120°C
 (Applicable model: Flange motor type:
 MDM25-3, MDM32-2 All sizes of long coupling type)
 T: 120 to 150°C
- Special version**
 A: Without drain + With base
 S: Without drain + With base + Special version
 D: With drain + With base
 X: With drain + With base + Special version
 B: Without drain + Without base
 Y: Without drain + Without base + Special version
 E: With drain + Without base
 Z: With drain + Without base + Special version
- Motor pole**
 2: 2 pole 4: 4 pole
- Standard for pipe connection and motor**
 I: ISO flange + IEC motor J: JIS flange + JIS motor

Note: Long coupling type is designed for 50 cycle area.

Performance curves

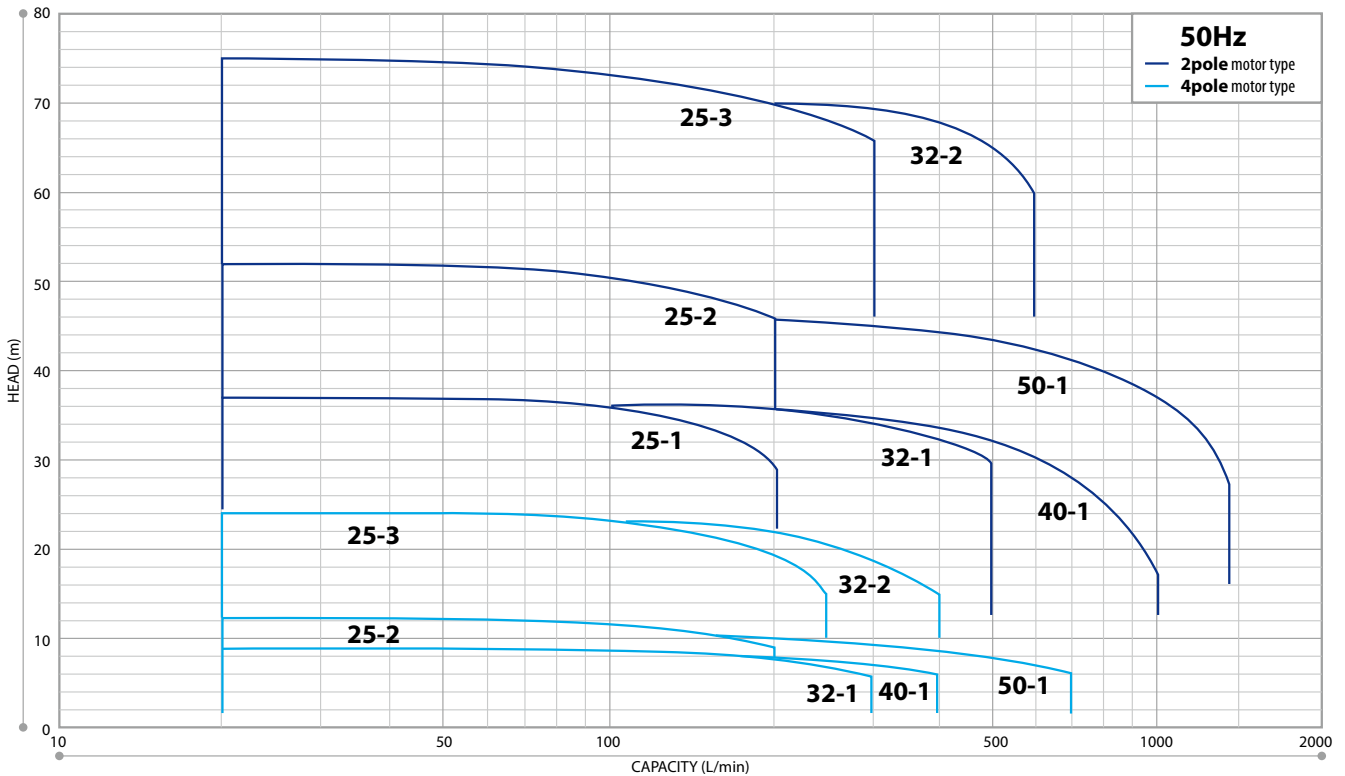

Iwaki dry running protector DR series (Option)

Model DR is electric current sensing type dry running protector. It detects the decreased load current (lower limit) to stop the pump when it runs dry or runs with air sucking in. It can detect over-load, too.



Specification

Specification		50/60Hz
Model	DR-20	
Motor power	380 to 440V	
Applied motor	0.75 to 15kW	
Power	V	200 to 240V 10% shingle phase
45-65Hz	Input	3.5W
Detective current	0.5 to 32.0A	
Current transformer(CT)	Built-in	
Current range	Auto	4.4/17.6/32A
	Manual	2.2/4.4/8.8/11/17.6/26.4/32A
Ambient	Temperature:0 to 40°C Humidity:RH40 to 85%	
Outer dimension in mm	D80 X W153 X H110	

- Current figure to be set is indicated on LCD.
- Both top/bottom figures can be set.
 - Top:Over-load
 - Bottom:Dry running, air sucking-in operation, operation with suction side closed
- Built-in current transformer
- DIN rail mounting

Dimensions

2 pole motor type

Flange motor type
(with base type)

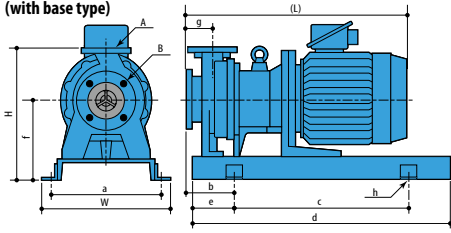

Flange motor type
(without base type)

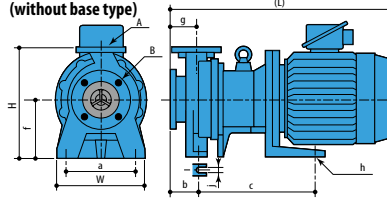

Long coupling type

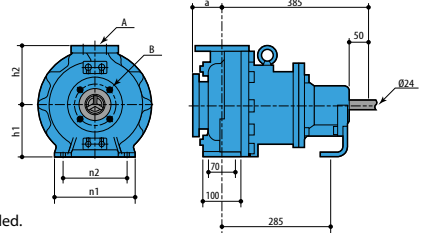

Note: The dimensions may differ with the type of motor installed.

Flange motor type with base

Model	Motor kW	(W)	(H)	(L)	a	b	c	d	e	f	g	h	A	B	Mass kg Less motor
MDM25-1	1.5	400	400	513	350	135	480	710	115	240	80	4×ø19	25	40	63
	2.2			542											
	4.0			625											
MDM25-2	5.5	400	430	689	350	150	540	800	130	250	80	4×ø19	25	40	89
	7.5			689											
	11			711											
MDM25-3	15	480	485	874	430	192	600	900	150	320	102	4×ø19	25	40	100
	7.5			874											
	11			874											
MDM32-1	4.0	400	410	625	350	150	540	800	130	250	80	4×ø19	32	50	84
	5.5			689											
	7.5			689											
MDM32-2	5.5	400	430	689	350	150	540	800	130	250	80	4×ø19	32	50	105
	7.5			852											
	11			852											
MDM40-1	4.0	400	410	625	350	150	540	800	130	250	80	4×ø19	40	65	85
	5.5			689											
	7.5			689											
MDM50-1	5.5	400	430	709	350	170	540	800	130	250	100	4×ø19	50	80	96
	7.5			872											
	11			872											

Flange motor type without base

Model	Motor kW	(W)	(H)	(L)	a	b	c	f	g	h	j	A	B	Mass kg Less motor
MDM25-1	1.5	180	310	513	130	100	150	150	80	2×ø15	15	25	40	37
	2.2			542										
	4.0			625										
MDM25-2	5.5	280	360	689	220	90	285	180	80	2×ø14	14	25	40	62
	7.5			365										
	11			365										
MDM25-3	5.5	280	345	711	220	112	365	180	102	2×ø14	14	25	40	70
	7.5			450										
	11			450										
MDM32-1	4.0	280	340	625	220	90	285	180	80	2×ø14	14	32	50	57
	5.5			365										
	7.5			365										
MDM32-2	5.5	280	360	689	220	90	365	180	80	2×ø14	14	32	50	75
	7.5			450										
	11			450										
MDM40-1	4.0	280	340	625	220	90	285	180	80	2×ø14	14	40	65	58
	5.5			365										
	7.5			365										
MDM50-1	5.5	280	360	709	220	110	365	180	100	2×ø14	14	50	80	69
	7.5			872										
	11			872										

Long coupling type without base, coupling, motor

Model	a	h1	h2	n1	n2	A	B	Mass kg Less motor
MDM32-1601	80	132	160	240	190	32	50	70
MDM32-2002		160	180					80
MDM40-1601		132	160					70
MDM50-1601	100	160	180	265	212	50	80	80

IWAKI CO., LTD.

6-6 Kanda-Sudacho 2-chome Chiyoda-ku Tokyo 101-8558 Japan TEL : (81)3 3254 2935 FAX : 3 3252 8892

www.iwakupumps.jp

The posting and copying from this catalogue without permission is not accepted firmly.

European office : IWAKI Europe GmbH
 Germany : IWAKI Europe GmbH
 Holland : IWAKI Europe GmbH (Netherlands Branch)
 Italy : IWAKI Europe GmbH (Italy Branch)
 Spain : IWAKI Europe GmbH (Spain Branch)
 Belgium : IWAKI Belgium N.V.
 Denmark : IWAKI Nordic A/S
 Finland : IWAKI Suomi Oy
 France : IWAKI France S.A.
 Norway : IWAKI Norge AS
 Sweden : IWAKI Sverige AB
 Switzerland : IWAKI (Schweiz) AG
 U.K. : IWAKI Pumps (UK) Ltd.

TEL: (49)2154 9254 0 FAX: 2154 9254 48
 TEL: (49)2154 9254 50 FAX: 2154 9254 55
 TEL: (31)547 293 160 FAX: 547 292 332
 TEL: (39)0444 371 115 FAX: 0444 335350
 TEL: (34)93 37 70 198
 TEL: (32)13 67 02 00 FAX: 13 67 20 30
 TEL: (45)48 24 2345 FAX: 48 24 2346
 TEL: (358)9 2745810 FAX: 9 2742715
 TEL: (33)1 69 63 33 70 FAX: 1 64 49 92 73
 TEL: (47)23 38 49 00 FAX: 23 38 49 01
 TEL: (46)8 511 72900 FAX: 8 511 72922
 TEL: (41)26 674 93 00 FAX: 26 674 93 02
 TEL: (44)1743 231363 FAX: 1743 366507

U.S.A. : IWAKI America Inc.
 Argentina : IWAKI America Inc. (Argentina Branch)
 Singapore : IWAKI Singapore Pte Ltd.
 Malaysia : IWAKI Sdn. Bhd.
 Indonesia : IWAKI Singapore (Indonesia Branch)
 Australia : IWAKI Pumps Australia Pty Ltd.
 China : IWAKI Pumps Co., Ltd.
 Korea : IWAKI Korea Co., Ltd.
 Taiwan : IWAKI Pumps Taiwan Co., Ltd.
 Thailand : IWAKI (Thailand) Co., Ltd.
 Vietnam : IWAKI Pumps Vietnam Co., Ltd.

TEL: (1)508 429 1440 FAX: 508 429 1386
 TEL: (54)11 4745 4116
 TEL: (65)6316 2028 FAX: 6316 3221
 TEL: (60)3 7803 8807 FAX: 3 7803 4800
 TEL: (62)21 6906606 FAX: 21 6906612
 TEL: (61)2 9899 2411 FAX: 2 9899 2421
 TEL: (852)2607 1168 FAX: 2607 1000
 TEL: (82)2 2630 4800 FAX: 2 2630 4801
 TEL: (886)2 8227 6900 FAX: 2 8227 6818
 TEL: (66)2 322 2471 FAX: 2 322 2477
 TEL: (84)613 933456 FAX: 613 933399

()Country codes

⚠ Caution for safety use: Before use of pump, read instruction manual carefully to use the product correctly.
 Actual pumps may differ from the photos. Specifications and dimensions are subject to change without prior notice. For further details please contact us.

⚠ Legal attention related to export.
 Our products and/or parts of products fall in the category of goods contained in control list of international regime for export control. Please be reminded that export license could be required when products are exported due to export control regulations of countries.

